

## CENIK PREZRAČEVANJA 2023



# Živite bolj zdravo

## Prezračevalni sistemi BRINK in UBBINK

### Certifikati



### Podatkovni listi

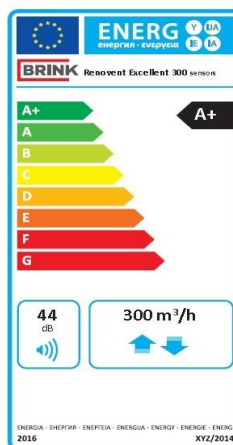

Za prezračevalni sistem dobite nepovratna sredstva s strani Eko sklada





KAZALO	stran
<b>Lokalna prezračevalna naprava Air 70</b>	<b>4</b>
	
<b>Prezračevalne naprave Brink Flair, SKY, Renovent Excellent</b>	<b>5-14</b>
	
<b>Garancijski zagon prezračevalne naprave Brink Renovent</b>	<b>15</b>
	
<b>Dodatki za prezračevalne naprave Brink Renovent, vlaženje v kanalu, filtracija, pohlajevanje</b>	<b>16 -22</b>
	
<b>Komore</b>	<b>23 -25</b>
	
<b>Air Excellent</b>	<b>26 - 30</b>
	
<b>Distribucijski elementi</b>	<b>31 - 33</b>
	
<b>Filtri za prezračevalne naprave</b>	<b>34</b>
	

## LOKALNA PREZRAČEVALNA NAPRAVA AIR 70

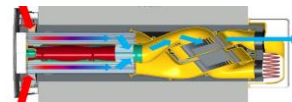

**EKO SKLAD**  
SLOVENSKI OKOLJSKI  
JAVNI SKLAD



Naziv	Opis	Koda	Cena	
			Zunanja rešetka - bela RAL 9010	Zunanja rešetka - nerjaveče jeklo
<b>AIR70 lokalni rekuperator</b>	Zmogljivost: 70 m3/h, tiha in nizkoenergijska naprava z bypassom, predgrelnikom, prikazovalnikom pretoka zraka na napravi, enostavna montaža, garancija 24 mesecev. Izkoristek rekuperacije po EN 13141-8 znaša 79%.	koda	<b>BR450050</b>	<b>BR450052</b>
		cena	<b>1.392,00</b>	<b>1.441,00</b>
<b>AIR70 Plus lokalni rekuperator</b>	Zmogljivost: 70 m3/h, tiha in nizkoenergijska naprava z bypassom, predgrelnikom, prikazovalnikom pretoka zraka na napravi, enostavna montaža, plus verzija, ki omogoča dodaten priklop CO2 senzorja, senzorja vlage, stikala za vklop in izklop, garancija 24 mesecev. Izkoristek rekuperacije po EN 13141-8 znaša 79%.	koda	<b>BR450051</b>	<b>BR450053</b>
		cena	<b>1.475,00</b>	<b>1.517,00</b>
<b>Podaljševalne cevi za lokalni rekuperator AIR 70</b>				
	za steno debeline 600-700	koda	<b>BR600-700</b>	
		cena	<b>230,00</b>	
 <b>ohišje fasadne rešetke</b>	za steno debeline 550-600		element ni potreben	
	za steno debeline 450-500mm	koda	<b>BR451050</b>	<b>BR452050</b>
		cena	<b>100,00</b>	<b>145,00</b>
	za steno debeline 400-450mm	koda	<b>BR451051</b>	<b>BR452051</b>
		cena	<b>100,00</b>	<b>145,00</b>
	za steno debeline 350-400mm	koda	<b>BR451052</b>	<b>BR452052</b>
	cena	<b>100,00</b>	<b>145,00</b>	
za steno debeline 300-350mm	koda	<b>BR451053</b>	<b>BR452053</b>	
	cena	<b>100,00</b>	<b>145,00</b>	
za steno debeline 270-300mm	koda	<b>BR451054</b>	<b>BR452054</b>	
	cena	<b>100,00</b>	<b>145,00</b>	
<b>Dodatki za lokalni rekuperator AIR 70 - samo PLUS verzija</b>				
		Koda		Cena
CO2 senzor s kablom		<b>BR450101</b>		<b>289,00</b>
senzor vlage s kablom		<b>BR450102</b>		<b>202,00</b>
Brink Home Set		<b>BR450103</b>		<b>322,50</b>
4-stopenjsko stensko stikalo		<b>BR540262</b>		<b>92,00</b>
<b>Filtri za lokalni rekuperator AIR70</b>				
filter komplet	2 x G4 in 1 x F7	<b>BR450109</b>		<b>64,00</b>
filter komplet	3 x G4	<b>BR536006</b>		<b>28,00</b>



Notranja rešetka 38x38cm



Zunanja rešetka 30x36cm



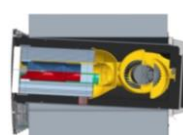











Okolica



Prostor

**PREZRAČEVALNE NAPRAVE BRINK RENOVENT**

**BRINK**

RENOVENT SKY 150 - PETG		Orientacija	standard
 <p>EKO SKLAD SLOVENSKI OKOLJSKI JAVNI SKLAD</p> <p>Maks. pretok zraka 150m<sup>3</sup>/h, stropna/stenska montaža, 100% obvod zraka - avt., PETG prenosnik, vgrajen predgrelnik. Krmilnik in sifon nista vključena. 5-letna garancija s petimi kompleti filtrov. 83% izkoristek po Eco design in EN13141-7</p>	  	teža (GxŠxD) priključki	24,5 kg 198 x 660 x 1000 ø 125 mm
		koda (standard)	BR423000
		cena	<b>2.486,00</b>
		  <b>5-letna garancija</b>	
RENOVENT SKY 150 PLUS - PETG		Orientacija	standard
 <p>EKO SKLAD SLOVENSKI OKOLJSKI JAVNI SKLAD</p> <p>Maks. pretok zraka 150m<sup>3</sup>/h, stropna/stenska montaža, 100% obvod zraka - avt., PETG prenosnik, vgrajen predgrelnik. Verzija plus omogoča priključitev dodatne opreme. Krmilnik in sifon nista vključena. 5-letna garancija s petimi kompleti filtrov. 83% izkoristek po Eco design in EN 13141-7.</p>	  	teža (GxŠxD) priključki	24,5 kg 198 x 660 x 1000 ø 125 mm
		koda (standard)	BR423001
		cena	<b>2.778,00</b>
		  <b>5-letna garancija</b>	
RENOVENT SKY 200 - PETG		Orientacija	standard
 <p>EKO SKLAD SLOVENSKI OKOLJSKI JAVNI SKLAD</p> <p>Maks. pretok zraka 200m<sup>3</sup>/h, stropna/stenska montaža, 100% obvod - avt., PETG prenosnik, vgrajen predgrelnik. Krmilnik in sifon nista vključena. 5-letna garancija s petimi kompleti filtrov. 83% izkoristek po Eco design in EN13141-7</p>	  	teža (GxŠxD) priključki	24,5 kg 198 x 660 x 1000 ø 160 mm
		koda (standard)	BR424000
		cena	<b>2.597,00</b>
		  <b>5-letna garancija</b>	

RENOVENT SKY 200 PLUS - PETG		Orientacija	standard
 <p>EKO SKLAD SLOVENSKI OKOLJSKI JAVNI SKLAD</p> <p>Maks. pretok zraka 200m<sup>3</sup>/h, stropna/stenska montaža, 100% obvod zraka – avt., PETG prenosnik, vgrajen predgrelnik. Verzija plus omogoča priključitev dodatne opreme.</p> <p>Krmilnik in sifon nista vključena. 5-letna garancija s petimi kompleti filtrov. 83% izkoristek po Eco design in EN 13141-7.</p>	 	teža (GxŠxD) priključki	24,5 kg 198 x 660 x 1000 ø 160 mm
		koda (standard)	BR424001
		cena	<b>2.891,00</b>
		  <b>5-letna garancija</b>	

RENOVENT SKY 300 - PETG		Orientacija	standard
 <p>EKO SKLAD SLOVENSKI OKOLJSKI JAVNI SKLAD</p> <p>Maks. pretok zraka 300m<sup>3</sup>/h, stropna/stenska montaža, 100% obvod zraka - avt., PETG prenosnik. Predgrelnik, krmilnik in sifon niso vključeni. 5-letna garancija s petimi kompleti filtrov. 84% izkoristek po Eco design in EN 13141-7</p>	 	teža (GxŠxD) priključki	37 kg 310 x 664 x 1185 ø 150 mm ø 160 mm
		koda (standard)	BR422004
		cena	<b>2.660,00</b>
		  <b>5-letna garancija</b>	

RENOVENT SKY 300 PLUS - PETG		Orientacija	standard
 <p>EKO SKLAD SLOVENSKI OKOLJSKI JAVNI SKLAD</p> <p>Maks. pretok zraka 300m<sup>3</sup>/h, stropna/stenska montaža, 100% obvod zraka – avt., PETG prenosnik. Verzija plus omogoča priključitev dodatne opreme. Predgrelnik, krmilnik in sifon niso vključeni. 5-letna garancija s petimi kompleti filtrov. 84% izkoristek po Eco design in EN 13141-7.</p>	 	teža (GxŠxD) priključki	37 kg 310 x 664 x 1185 ø 150 mm ø 160 mm
		koda (standard)	BR422005
		cena	<b>2.955,00</b>
		  <b>5-letna garancija</b>	

Če želite na napravo Renovent Sky 150/200/300 priljučiti dodatno opremo, potrebujete Priključni box, ki ga najdete pod dodatki za naprave.

RENOVENT SKY 150 in 200

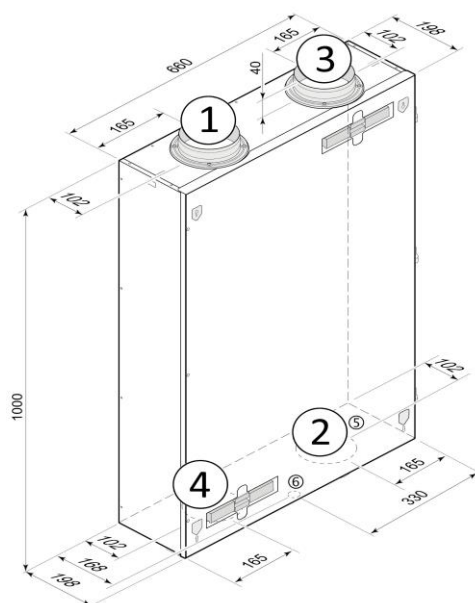



Za stensko in stropno montažo



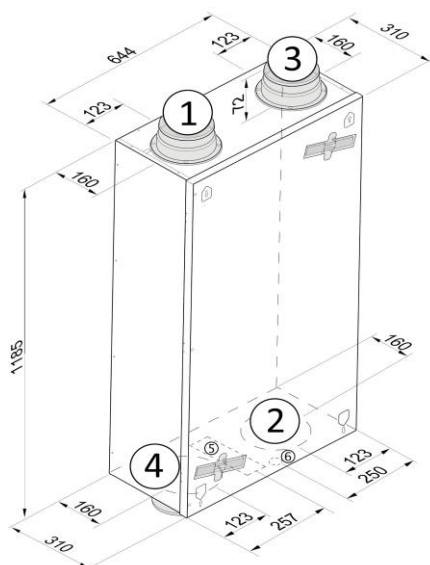

- 1. V PROSTOR 
- 2. V OKOLJE 
- 3. IZ PROSTORA 
- 4. IZ OKOLICE 





- 5. ELEKTRIČNA POVEZAVA
- 6. KONDENZ

RENOVENT SKY 300







RENOVENT EXCELLENT 180 - PETG		Orientacija	4/0 desni	4/0 levi
 <p>EKO SKLAD SLOVENSKE OKOLJSKE JAVNE AGENCIJE</p>	  	teža (Š x V x G) priključki	25 kg 560 x 600 x 315 ø 125 mm	
		koda (standard)	BR282000	BR282010
<p>Maks. pretok zraka 180m<sup>3</sup>/h pri 150Pa, funkcijski obvod zraka - avt., PETG prenosnik, osnovni krmilnik. Ne vključuje sifona in predgrelnika. 5-letna garancija s petimi kompleti filtrov. 84% izkoristek po Eco design in EN 13141-7.</p>		cena	2.108,00 €	2.108,00 €
  <b>5-letna garancija</b>				

RENOVENT EXCELENT 300		Orientacija	4/0 desni	4/0 levi
 <p>EKO SKLAD SLOVENSKE OKOLJSKE JAVNE AGENCIJE</p>		teža (Š x V x G) priključki	38 kg 675 x 765 x 564 ø 160 mm	
		koda (standard)	BR410031	BR411032
<p>Maks. pretok zraka 300m<sup>3</sup>/h pri 250Pa, s 100% obvodom - avt., PETG prenosnik, vgrajen predgrelnik in osnovni krmilnik. Sifon ni vključen. 5-letna garancija s petimi kompleti filtrov. 86% izkoristek po Eco design in EN 13141-7.</p>		cena	2.804,00 €	2.804,00 €
  <b>5-letna garancija</b>				

RENOVENT EXCELENT 400		Orientacija	4/0 desni	4/0 levi
 <p>EKO SKLAD SLOVENSKE OKOLJSKE JAVNE AGENCIJE</p>		teža (Š x V x G) priključki	38 kg 675 x 765 x 564 ø 180 mm	
		koda (standard)	BR420024	BR421024
<p>Maks. pretok zraka 400m<sup>3</sup>/h pri 215Pa, s 100% obvodom - avt., PETG prenosnik, vgrajen predgrelnik in osnovni krmilnik. Sifon ni vključen. 5-letna garancija s petimi kompleti filtrov. 85% izkoristek po Eco design in EN 13141-7.</p>		cena	3.086,00 €	3.086,00 €
  <b>5-letna garancija</b>				





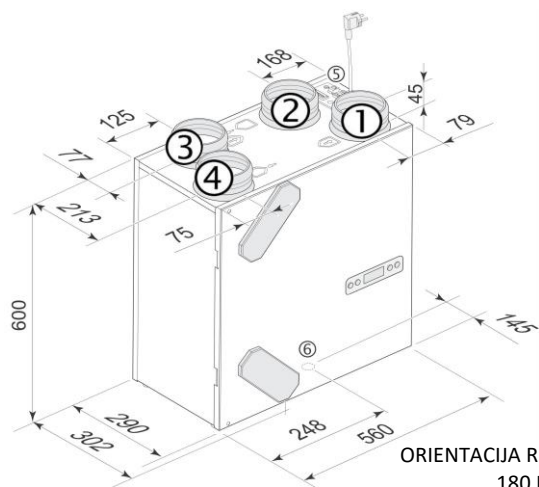

RENOVENT EXCELENT 450		Orientacija	standard	
 <p><b>EKO SKLAD</b> SLOVENSKI OKOLJSKI JAVNI SKLAD</p>		teža (Š x V x G) priključki	38 kg 677 x 765 x 564 ø 180 mm	
		koda (standard)	BR420200	BR421200
<p>Maks. pretok zraka 450m<sup>3</sup>/h pri 125Pa, s 100% obvodom-avt., PETG prenosnik, vgrajen predgrelnik in osnovni krmilnik. Sifon ni vključen.</p> <p>5-letna garancija s petimi kompleti filtrov. 84% izkoristek po Eco design in EN 13141-7.</p>		cena	<b>3.324,00 €</b>	<b>3.324,00 €</b>
  <b>5-letna garancija</b>				

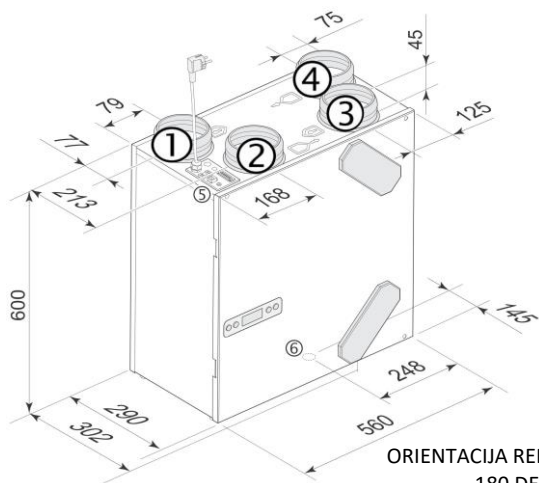

ORIENTACIJA REN. EXCELENT  
180 LEVI



ORIENTACIJA REN. EXCELENT  
180 DESNI

- 1. V PROSTOR 
- 2. V OKOLJE 
- 3. IZ PROSTORA 
- 4. IZ OKOLICE 
- 5. ELEKTRIČNA POVEZAVA
- 6. KONDENZ

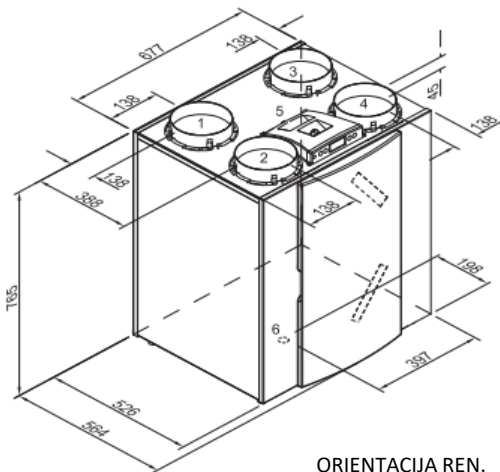

ORIENTACIJA REN.  
EXCELLENT  
300 & 400 DESNI

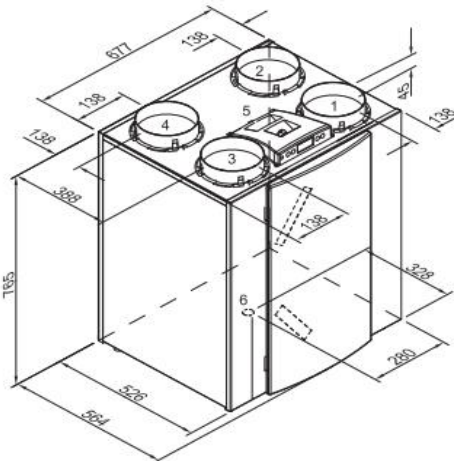

ORIENTACIJA REN EXCELLENT  
300 & 400 LEVI

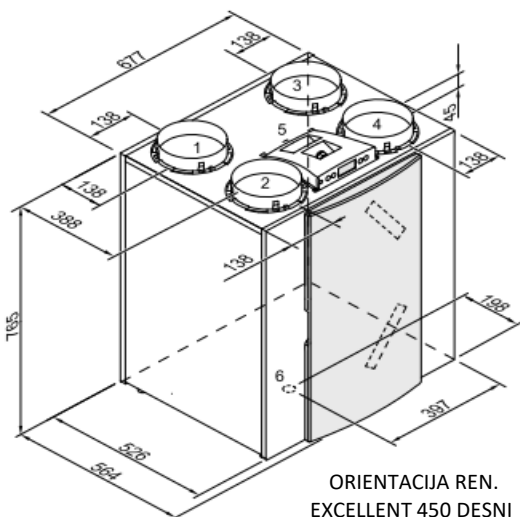

ORIENTACIJA REN.  
EXCELLENT 450 DESNI

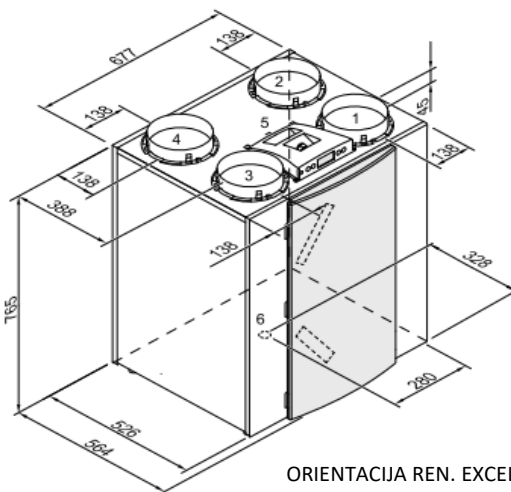

ORIENTACIJA REN. EXCELLENT 450 LEVI

1. V PROSTOR



2. V OKOLJE



3. IZ PROSTORA









4. IZ OKOLICE







-----

## PREZRAČEVALNE NAPRAVE BRINK FLAIR

FLAIR 225		Orientacija	4/0 desni	4/0 levi	
 <p><b>EKO SKLAD</b> SLOVENSKI OKOLJSKI JAVNI SKLAD</p> <p>Maks. pretok zraka 225m<sup>3</sup>/h pri 250Pa, rekuperacija 92% (Ecodesign ErP), 89% (PHI). Vključuje 100% obvod – avt., PETG prenosnik, predgrelnik, sifon, vgrajen krmilnik na dotik. 5-letna garancija s petimi kompleti filtrov.</p>		teža (Š x V x G) Priključki	35 kg 600 x 650 x 455 mm Ø 125 mm		
		koda (standard)	BR428001	BR428000	
		cena	2.850,00	2.850,00	
		  <span style="color: red; font-weight: bold;">5-letna garancija</span>			

FLAIR 325		Orientacija	4/0 desni	2/2 desni	4/0 levi	2/2 levi	
 <p><b>EKO SKLAD</b> SLOVENSKI OKOLJSKI JAVNI SKLAD</p> <p>Maks. pretok zraka 325m<sup>3</sup>/h pri 250Pa, rekuperacija 91% (Ecodesign ErP), 89% (PHI). Vključuje 100% obvod – avt., PETG prenosnik, predgrelnik, sifon, vgrajen krmilnik na dotik. 5-letna garancija s petimi kompleti filtrov.</p>		teža (Š x V x G) Priključki	37 kg 750 x 650 x 560 mm Ø 160 mm				
		koda (standard)	BR430001	BR430101	BR430000	BR430100	
		cena	3.086,00	3.086,00	3.086,00	3.086,00	
		  <span style="color: red; font-weight: bold;">5-letna garancija</span>					

FLAIR 400		Orientacija	4/0 desni	2/2 desni	4/0 levi	2/2 levi	
 <p><b>EKO SKLAD</b> SLOVENSKI OKOLJSKI JAVNI SKLAD</p> <p>Maks. pretok zraka 400m<sup>3</sup>/h pri 270Pa, rekuperacija 92% (Ecodesign ErP), 89% (PHI). Vključuje 100% obvod – avt., PETG prenosnik, predgrelnik, sifon, vgrajen krmilnik na dotik. 5-letna garancija s petimi kompleti filtrov.</p>		teža (Š x V x G) Priključki	37 kg 750 x 650 x 560 mm Ø 180 mm				
		koda (standard)	BR431001	BR431101	BR431000	BR431100	
		cena	3.327,00	3.327,00	3.327,00	3.327,00	
		  <span style="color: red; font-weight: bold;">5-letna garancija</span>					

Če želite na napravo Flair 325/400 priključiti dodatno opremo potrebujete Priključni Box, ki ga najdete pod dodatki za naprave.

\*PHI - Passive House Institute

FLAIR 450		Orientacija	4/0 desni	4/0 levi
 <p><b>EKO SKLAD</b> SLOVENSKI OKOLJSKI JAVNI SKLAD</p> <p>Maks. pretok zraka 450m<sup>3</sup>/h pri 200Pa, rekuperacija 92% (Ecodesign ErP), 92% (PHI). Vključuje 100% obvod – avt., PETG prenosnik, predgrelnik, sifon, vgrajen krmilnik na dotik. 5-letna garancija s petimi kompleti filtrov.</p>	  	teža (Š x V x G) Priključki	53kg 800 x 850 x 661 mm Ø 200 mm	
		koda (standard)	BR432001	BR432000
		cena	<b>4.227,00</b>	<b>4.227,00</b>
		  <b>5-letna garancija</b>		

FLAIR 600		Orientacija	4/0 desni	4/0 levi
 <p><b>EKO SKLAD</b> SLOVENSKI OKOLJSKI JAVNI SKLAD</p> <p>Maks. pretok zraka 600m<sup>3</sup>/h pri 190Pa, rekuperacija 92% (Ecodesign ErP), 90% (PHI). Vključuje 100% obvod – avt., PETG prenosnik, predgrelnik, sifon, vgrajen krmilnik na dotik. 5-letna garancija s petimi kompleti filtrov.</p>	  	teža (Š x V x G) Priključki	53kg 800 x 850 x 661 mm Ø 200 mm	
		koda (standard)	BR433001	BR433000
		cena	<b>4.785,00</b>	<b>4.785,00</b>
		  <b>5-letna garancija</b>		

# ORIENTACIJE PREZRAČEVALNE NAPRAVE FLAIR

## Flair 225

Desna različica

4/0

Leva različica

4/0

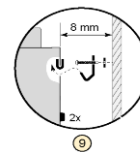
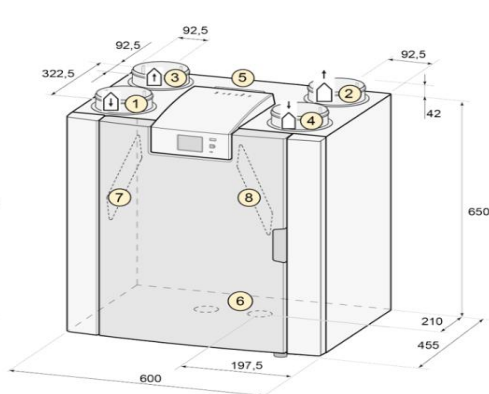
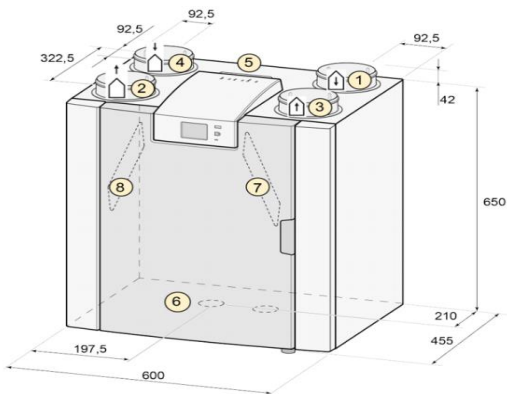

- 1. V PROSTOR
- 2. V OKOLJE
- 3. IZ PROSTORA
- 4. IZ OKOLICE
- 5. ELEKTRIČNA POVEZAVA
- 6. KONDENZ

## Flair 325/400

Desna različica

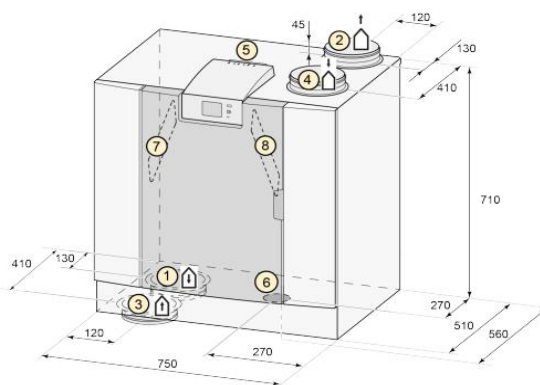
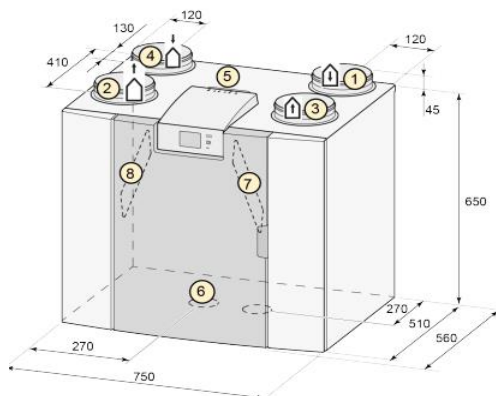

- 1. V PROSTOR
- 2. V OKOLJE
- 3. IZ PROSTORA
- 4. IZ OKOLICE
- 5. ELEKTRIČNA POVEZAVA
- 6. KONDENZ

Leva različica

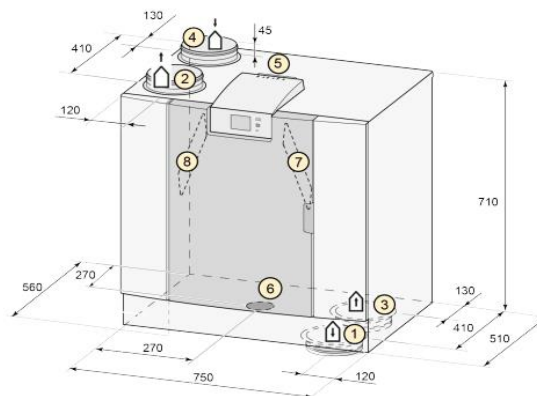
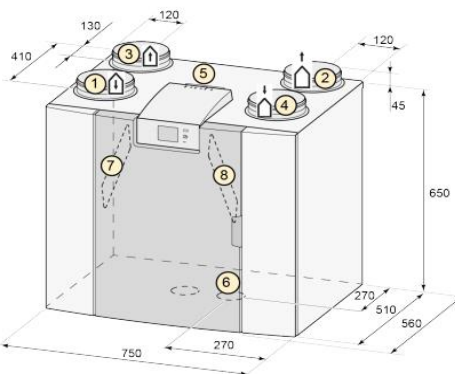

Flair 450/600

Leva različica

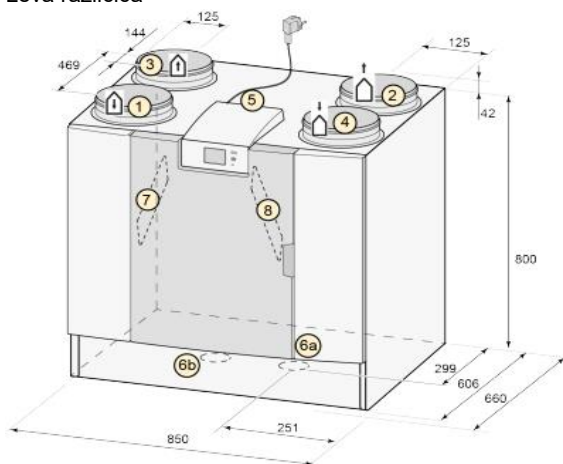

Desna različica

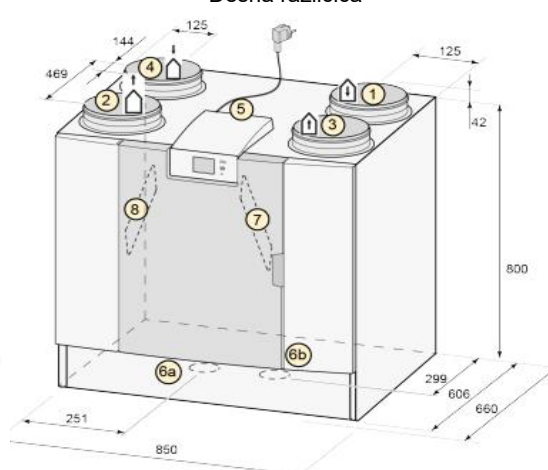













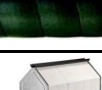

- 1. V PROSTOR 
- 2. V OKOLJE 
- 3. IZ PROSTORA 
- 4. IZ OKOLICE 
- 5. ELEKTRIČNA POVEZAVA
- 6. KONDENZ

**GARANCIJSKI ZAGON PREZRAČEVALNE NAPRAVE BRINK RENOVENT, FLAIR**

Koda	Naziv	Cena
STZAREN	Zagon prezračevalne naprave Brink	<b>100,00</b>
<p>Električne povezave za napravo: povezavo za regulator in dovod električne energije pripravi investitor pred izvedbo zagona.                      V garancijskem zagonu rekuperatorja je zajeto:</p> <ul style="list-style-type: none"> <li>- enkratni obisk serviserja na objektu,</li> <li>- montaža in povezava regulatorja z rekuperatorjem na pred-pripravljeno električno inštalacijo,</li> <li>- električni priklop naprave na pred-pripravljeno električno inštalacijo,</li> <li>- prvi vklop in nastavitev parametrov naprave,</li> <li>- potni in prevozni stroški do 60 km.</li> </ul> <p>Podatki za izvedbo povezav:</p> <ul style="list-style-type: none"> <li>- za stenski upravljalnik:</li> <li>1. 4-stopenjsko stikalo: kabel UTP CAT5 4x2x0.6mm2 od lokacije PODOMETNEGA stikala do naprave, pripraviti podometno dozo z vodoravno postavitvijo vijakov z razmakom 60 mm (primer sm 60-06) na predvideni lokaciji; ALI</li> <li>2. stenski žični daljinski upravljalnik Brink Air Control s prikazovalnikom: presek žice za povezavo stenskega daljinskega upravljalnika in rekuperatorja najmanj 2 x 0,34 mm2 in ne več kot 0,75 mm2, potrebo pripraviti podometno dozo z vodoravno postavitvijo vijakov z razmakom 60 mm (primer sm 60-06)</li> <li>- za rekuperator: 2x vtičnica 230V ob napravi (priključni kabel s šuko vtikačem na napravi je dolžine 1m) (1 x rekuperator, 1 x servisna vtičnica, v kolikor so prisotni še drugi dodatki se pripravi ustrezno število vtičnic)</li> </ul> <p>Montažo elektro instalacij v celoti izvede naročnik.                      V ceni zajeti potni in transportni stroški do 60 km (gledano obe smeri).</p>		

Koda	Naziv	Cena
STZANREN	Zagon prezračevalne naprave Brink z meritvijo in nastavitvijo količin zraka	<b>200,00</b>
<p>Električne povezave za napravo: povezavo za regulator in dovod električne energije pripravi investitor pred izvedbo zagona.                      V garancijskem zagonu rekuperatorja je zajeto:</p> <ul style="list-style-type: none"> <li>- enkratni obisk serviserja na objektu,</li> <li>- montaža in povezava regulatorja z rekuperatorjem na pred-pripravljeno električno inštalacijo,</li> <li>- električni priklop naprave na pred-pripravljeno električno inštalacijo,</li> <li>- prvi vklop in nastavitev parametrov naprave,</li> <li>- potni in prevozni stroški do 60 km.</li> <li>- <b>nastavitev količin zraka</b></li> </ul> <p>Podatki za izvedbo povezav:</p> <ul style="list-style-type: none"> <li>- za stenski upravljalnik:</li> <li>1. 4-stopenjsko stikalo: kabel UTP CAT5 4x2x0.6mm2 od lokacije PODOMETNEGA stikala do naprave, pripraviti podometno dozo z vodoravno postavitvijo vijakov z razmakom 60 mm (primer sm 60-06) na predvideni lokaciji; ALI</li> <li>2. stenski žični daljinski upravljalnik Brink Air Control s prikazovalnikom: presek žice za povezavo stenskega daljinskega upravljalnika in rekuperatorja najmanj 2 x 0,34 mm2 in ne več kot 0,75 mm2, potrebo pripraviti podometno dozo z vodoravno postavitvijo vijakov z razmakom 60 mm (primer sm 60-06)</li> <li>- za rekuperator: 2x vtičnica 230V ob napravi (priključni kabel s šuko vtikačem na napravi je dolžine 1m) (1 x rekuperator, 1 x servisna vtičnica, v kolikor so prisotni še drugi dodatki se pripravi ustrezno število vtičnic)</li> </ul> <p>Montažo elektro instalacij v celoti izvede naročnik.                      V ceni zajeti potni in transportni stroški do 60 km (gledano obe smeri).</p>		

**DODATKI ZA PREZRAČEVALNE NAPRAVE BRINK RENOVENT, FLAIR**

Naziv	Slika		Flair 225 DN125	Flair 325 DN160	Flair 400 DN180	Flair 450/600 DN200
4-stopenjsko stensko stikalo z indikacijo stanja filtra		koda	BR540262			
		cena	<b>92,00</b>			
stenski daljinski upravljalnik s prikazovalnikom, tedenski časovnik, pregled in upravljanje vseh funkcij naprave		koda	BR510498			
		cena	<b>269,00</b>			
Enostavni uporabniški vmesnik z zaslonom na dotik, Brink Touch Control		koda	BR532743			
		cena	<b>220,00</b>			
Brink Home za standardno in plus verzijo		koda	BR510510			
		cena	<b>365,00</b>			
tipalo vlage v kanalu		koda	BR310657			
		cena	<b>212,00</b>			
CO2 tipalo, priključitev na E-bus, za plus verzijo Renovent Excellent, Sky in vse verzije Flair		koda	BR532126			
		cena	<b>340,00</b>			
dogrelnik za plus verzije, za obe verziji Flair (navadni in plus)		koda	BR310730	BR310690	BR310692	BR310699
		cena	<b>340,00</b>	<b>427,50 €</b>	<b>427,50</b>	<b>478,00</b>
entalpijski izmenjevalnik <b>*samo za Flair 325/400</b>		koda	BR532710			
		cena	<b>2.117,50</b>			
Priključni Box (Plus verzija) za Flair 225/325/400, za priključitev dodatne opreme		koda	BR532700			
		cena	<b>270,00</b>			
podstavek za napravo, velikost podstavka (V x G x Š) 400 x 520 x 668 mm <b>samo za 4/0</b>		koda	BR217083	BR532708		BR532819
		cena	<b>156,75</b>	<b>169,00</b>		<b>209,00</b>
Modbus modul		koda	BR532121			
		cena	<b>380,00</b>			
kpl. za nadzorovano prezračevanje na osnovi časovnika 2.0		koda	BR310431			
		cena	<b>680,00</b>			
sifon s kroglico <b>*samo za naprave SKY</b> <b>*model Flair ima serijsko že vgrajen sifon s kroglico</b>		koda	OHSIFON			
		cena	<b>53,90</b>			
podometni sifon s kroglico <b>*priporočamo za SKY</b>		koda	OHSIFONPOD			
		cena	<b>43,00</b>			



**DODATKI ZA PREZRAČEVALNE NAPRAVE BRINK RENOVENT, FLAIR**

Naziv	Slika		SKY 150 & Excellent 180 DN125	SKY200/300 DN160	Excellent 300 DN160	Excellent 400/450 DN180
Predgrelnik serijsko vgrajen pri Flair, SKY 150/200,		koda	BR310740	BR310681		
		cena	<b>324,00</b>	<b>325,00</b>		
Dogrelnik za plus verzije, za obe verziji Flair (navadni in plus)		koda	BR310730	BR310671	BR310630	BR310650
		cena	<b>340,00</b>	<b>325,00</b>	<b>325,00</b>	<b>335,00</b>
Entalpijski izmenjevalnik <b>Sky 300</b>		koda		BR532060		
		cena		<b>1.683,00</b>		









**ELEMENTI ZA IZVEDBO ZAJEMA SVEŽEGA IN ODPADNEGA ZRAKA**

Naziv	Slika		Flair 225, Sky 150, Exc. 180 DN125	Flair 325, Sky 200/300 DN160	Flair 400 DN180	
strešni izolirani odvodni/dovodni priključek		koda	BR648710	BR648600	BR648670	
		cena	<b>157,50</b>	<b>179,00</b>	<b>185,00</b>	
izolirana strešna kapa, podaljšana pod streho, črna PP <i>*del kompleta*</i>		koda		UB169859	UB169860	
		cena		<b>156,00</b>	<b>284,00</b>	
Strešni okvir za kapo, univerzalna za nagib 25° - 45°, črn, 500x600mm <i>*del kompleta*</i>		koda		UB174132	UB174136	
		cena		<b>150,00</b>	<b>272,00</b>	
Stenski pritrdilni obroč <i>*del kompleta*</i>		koda		UB169075	UB169082	
		cena		<b>7,70</b>	<b>8,16</b>	
Pribor za zajem zraka skozi zid (izolirana cev z manšeto), dolžine 100 mm, v INOX izvedbi		koda		KO648730IN	KO648660IN	KO648690IN
		cena		<b>156,25</b>	<b>160,00</b>	<b>172,50</b>
Pribor za zajem zraka skozi zid (izolirana cev z manšeto), barva RAL 9010 cev skrajšana na 100 mm		koda	KO648730	KO648660	KO648690	
		cena	<b>100,00</b>	<b>103,75</b>	<b>107,50</b>	
2 v 1 fasadni element INOX za zajem in izpust zraka		koda	KO2V1DN125INOX	KO2V1DN160INOX	KO2V1DN180INOX	
		cena	<b>225,00</b>	<b>250,00</b>	<b>275,00</b>	
1 fasadni element iz poc. ploč, barva RAL 9010, za zajem in izpust zraka		koda	KO2V1DN125	KO2V1DN160	KO2V1DN180	
		cena	<b>148,20</b>	<b>162,50</b>	<b>187,50</b>	
Aerfoam - EPE cev, izolirana, L=2000 mm		koda	UB188202	UB188210	UB188206	
		cena	<b>50,70</b>	<b>53,80</b>	<b>60,10</b>	
Aerfoam - EPE koleno, izolirano 90°		koda	UB188263	UB188225	UB188283	
		cena	<b>10,00</b>	<b>14,00</b>	<b>18,50</b>	
Aerfoam - EPE koleno, izolirano 45°		koda	UB188262	UB188224	UB188282	
		cena	<b>7,20</b>	<b>8,60</b>	<b>9,90</b>	
Aerfoam - spojka za EPE cevi		koda	UB188265	UB188255	UB188285	
		cena	<b>7,40</b>	<b>7,40</b>	<b>7,40</b>	
Aerfoam - obešalo za EPE cevi		koda	UB169141	UB169139	UB169143	
		cena	<b>4,90</b>	<b>4,90</b>	<b>4,90</b>	
spojka iz pocinkane pločevine		koda	PRSK125	PRSK160	PRSK180	
		cena	<b>3,30</b>	<b>3,50</b>	<b>3,70</b>	
element za predpripravo odprtine v AB plošči, DN 125		koda	PREPAB125			
		cena	<b>24,00</b>			
reducirni kos DN 160-180		koda		PRRED180/160		
		cena		<b>10,40</b>		





**ELEMENTI ZA IZVEDBO ZAJEMA SVEŽEGA IN ODPADNEGA ZRAKA**

		<b>Flair 450, 600 DN200</b>			
Strešni izolirani odvodni/dovodni priključek		koda	BR648770		
		cena	<b>186,00</b>		
Pribor za zajem zraka skozi zid (izolirana cev z manšeto), dolžine 100 mm, v INOX izvedbi		koda	KO648699IN		
		cena	<b>172,50</b>		
Pribor za zajem zraka skozi zid (izolirana cev z manšeto), barva RAL 9010 cev skrajšana na 100 mm		koda	KO648699		
		cena	<b>107,50</b>		
2 v 1 fasadni element INOX za zajem in izpust zraka		koda	KO2V1DN200INOX		
		cena	<b>330,00</b>		
2 v 1 fasadni element iz poc. ploč, barva RAL 9010, za zajem in izpust zraka		koda	KO2V1DN200		
		cena	<b>216,00</b>		
Aerfoam - EPE cev, izolirana, L=2000 mm		koda	UB188218		
		cena	<b>104,20</b>		
Aerfoam - EPE koleno, izolirano 90 °		koda	UB188227		
		cena	<b>24,50</b>		
Aerfoam - EPE koleno, izolirano 45 °		koda	UB188226		
		cena	<b>15,20</b>		
Aerfoam - spojka za EPE cevi		koda	UB188254		
		cena	<b>8,10</b>		
Aerfoam - obešalo za EPE cevi		koda	UB169148		
		cena	<b>8,60</b>		
Spojka iz pocinkane pločevine		koda	PRSK200		
		cena	<b>3,90</b>		
Reducirni kos DN 180-200		koda	PRRED180/200		
		cena	<b>10,80</b>		
<b>DUŠILNIKI ZVOKA</b>					
Cev fleksibilna izolirana sonoconnect (prodaja po 10 m) (spajanje Aerfoam s spojko iz pocinkane pločevine)		koda	PRCEVFLEKSSON140	PRCEVFLEKSSON180	PRCEVFLEKSSON203
		cena/10 m	<b>68,80</b>	<b>83,40</b>	<b>88,70</b>
Fleksibilni cevni dušilnik zvoka iz aluminija		koda	PRDZ125-180-1	PRDZ160-200-1	PRDZ180-250-1
		cena 1 m	<b>70,80</b>	<b>78,00</b>	<b>102,00</b>
		koda	PRDZ125-180-1,5	PRDZ160-200-1,5	PRDZ180-250-1,5
		cena 1,5 m	<b>78,00</b>	<b>91,20</b>	<b>120,00</b>
		koda	PRDZ200-250-1	PRDZ200-250-1,5M	
		cena 1 m	<b>126,00</b>		
cena 1,5 m		<b>162,00</b>			

**DODATKI NA PREZRAČEVALNEM SISTEMU - VLAŽENJE**

Naziv	Slika		Flair225 DN125	Flair 325 DN160	Flair 400 DN180	Sky 300 DN160
Vlažilnik HomEvap		koda	HEPH			
		cena	1.605,00			
Nadomestni vložek "Legiosafe"		koda	HEPCAH			
		cena	316,00			
Nadomestno satje vložka "Legiosafe"		koda	HEMATB			
		cena	120,00			
Nadomestni vložek HomEvap "Cooler"		koda	HEPCAC			
		cena	231,00			
Reducirni kos 160/200		koda		PRRED160/200		PRRED160/200
		cena		6,30		6,30
Reducirni kos 180/200		koda			PRRED180/200	
		cena			10,80	
Reducirni kos DN200 - DN125, potrebna 2 kos-a		koda	PRRED125/200			
		cena	8,20			
Spojni kos iz pocinkane pločevine fi 201/201 za HomEvap		koda	PRSK201EVAP			
		cena	12,60			

**DODATKI NA STRANI VODE/VLAŽENJU - MEHČANJE IN FILTRACIJA VODE**

<b>Naležni magnetni filter brez napajnja</b> PRIZMAG R 1/2" - R 3/4" priporočljiv na dovodni cevi pred HomEvap-om		koda	VOEKOM82242			
		cena	187,00			
<b>Cevni magnetni filter</b> Magnetni nevtralizator R 1/2" priporočljiv na dovodni cevi pred HomEvap-om		koda	VOEKOM80026			
		cena	47,00			
<b>Cevni magnetni filter</b> Magnetni nevtralizator R 3/4" priporočljiv na dovodni cevi pred HomEvap-om		koda	VOEKOM80033			
		cena	49,00			
<b>Cevni magnetni filter</b> Magnetni nevtralizator R 1"		koda	VOEKOM80040			
		cena	89,00			
<b>Cevni magnetni filter in filter nečistoč</b> SAMMG MARGO EKO FOS 3/4" priporočljiv na dovodni cevi pred HomEvap-om		koda	VOEKOM83522			
		cena	168,00			
<b>Cevni magnetni filter in filter nečistoč za cel sistem</b> Trojni filter EKO TRIPLEX-MAGO-EKO-FOS 3/4" - VIŠINA 10"		koda	VOEKOM83409			
		cena	204,00			
Reversno osmozni čistilnik pitne vode		koda	VOM140RO030			
		cena	229,00			
Vložek filtra 50 - 60 mcr. Za samočistilni filter GREEN		koda	VOEKOM82822			
		cena	15,00			
Kombirnirani vložek filtra 25 mcr. S sredstvom proti koroziji.		koda	VOEKOM88879			
		cena	17,00			
Vložek filtra z aktivnim ogljem 5 mcr.		koda	VOEKOM82624			
		cena	14,00			

**DODATKI NA PREZRAČEVALNEM SISTEMU – FILTRACIJA ZRAKA**

Naziv	Slika		Flair225 DN125	Flair 325 DN160	Flair 400 DN180	Sky 300 DN160
Pure induct - Modularni dodatek k prezračevanju za filtriranje zraka z uporabo ionizacije. Učinkovit proti: prahu, nano delcem, virusom, bakterijam in vonjavam.		koda	BR351000			
		cena	1.196,00			
Filter Pure induct F7		koda	BR351003			
		cena	97,00			
Reducirni kos DN200 - DN160, potrebna 2 kos-a		koda	PRRED125/200	PRRED160/200	PRRED180/200	PRRED160/200
		cena	8,20 €	6,30	10,80	6,30

## DODATKI NA PREZRAČEVALNEM SISTEMU - Pohlajevanje v kanalu z DUF-om 2,5 kW

Naziv	Cena	Koda
Elektro omara za pohlajevanje v kanalu z DUF-om in sobnim termostatom	740,48	INHLKELOMARA
Hlajenje v kanalu z DUF-om delo izoliranja (na meter)	3,20	INHLKIZOLIRANJE
Zunanja enota Fujitsu AOYG09FREO	616,98	FUAOYG09FREO
Zunanja enota Fujitsu AOYG12FREO	711,36	FUAOYG12FREO
DUF 2,5kW, izoliran	1019,16	INHLKDUFTPS2,5
DUF 3,4kW, izoliran	1067,04	INHLKDUFTPS3,4



Material-izolacija dovoda sistema		
Izolacija cevak ST 09 x 76	4,30	PRIZST09X76
Izolacija za adapterje in komore (ST10) - samolepilna	16,20	IZST10mm-1M2SAMO
Izolacijski samolepilni trak širine 10 cm, debeline 3 mm in dolžine 15 m	38,30	IZT100X3X15MST
Zagon sistema		
Frigo zagon Remty-R ali zunanji - sočasno z zagonom prezračevanja	90,00	STZAFREO1
Frigo zagon Remty-R - ločen prihod	140,00	STZAFREO2
Frigo montaža		
Frigo montaža kanalske klime Fujitsu 2,5 kW	390,40	MONTAFREO2,5
Frigo montaža kanalske klime Fujitsu 3,4 kW	440,00	MONTAFREO3,4

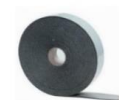
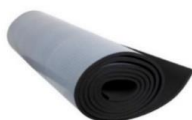

### V ceniku ni zajeto:

Gradbena in zaključna dela;



Električne povezave (napajanje klime in komunikacijske povezave). Ta dela pripravi za to usposobljen inštalater v skladu s predhodnim dogovorom.







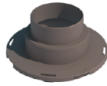
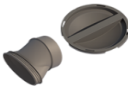

Potrebna predpriprava - elektroinštalacijski priključki, vtičnice, vodovodni odtok pripravi investitor v skladu z navodili, ki jih posreduje Remty-R.

Za izdelavo sistema kanalskega pohlajevanja morajo biti vsi dovodni kanali od izmenjevalnika, glavne razdelilne komore in do končne komore ventila izolirani z izolacijo za hladilne sisteme debeline vsaj 9mm.

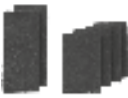

## KOMORE

Naziv		Flair 325 DN160	Flair 400 DN180	Sky 150, Exc. 180, Flair 225 DN125	Sky 200/300 DN160
DBOX206, komora plastična 6 x DN75, priključek DN 125 ali 160 ali 180, 3x čep, 6x regulacijski element		koda	UB188644		
		št. priključkov	<b>6</b>		
		cena	<b>143,50</b>		
DBOX208, komora plastična 8 x DN75, priključek DN 125 ali 160 ali 180, 4x čep, 8x regulacijski element		koda	UB188646		
		št. priključkov	<b>8</b>		
		cena	<b>143,30</b>		
DBOX 212, komora plastična 12 x DN75, priključek Φ 125 ali 160 ali 180, 6x čep, 12x regulacijski element		koda	UB188630		
		št. priključkov	<b>12</b>		
		cena	<b>215,00</b>		
DBOX 212 INLINE, komora plastična 12 x DN75, priključek DN 125 ali 160 ali 180, 6x čep, 12x regulacijski element		koda	UB188633		
		št. priključkov	<b>12</b>		
		cena	<b>238,09</b>		
DBOX 216, komora plastična 16 x DN75, priključek DN 125 ali 160 ali 180, 8x čep, 16x regulacijski element		koda	UB188631		
		št. priključkov	<b>16</b>		
		cena	<b>214,67</b>		
DBOX 808, komora plastična 8 x DN75, priključek DN 125 ali 160 ali 180, 4x čep, 8x regulacijski element		koda	UB188583		
		št. priključkov	<b>8</b>		
		cena	<b>275,13</b>		
DBOX 816, komora plastična 16 x DN75, priključek DN 125 ali 160 ali 180, 8x čep, 16x regulacijski element		koda	UB188581		
		št. priključkov	<b>16</b>		
		cena	<b>279,82</b>		
DBOX 824, komora plastična 24 x DN75, priključek DN 125 ali 160 ali 180, 20x čep, 20x regulacijski element		koda	UB188588		
		št. priključkov	<b>24</b>		
		cena	<b>300,91</b>		
reducirni kos DN 125-160-180		koda	UB188565		
		cena	<b>16,00</b>		

Naziv		Flair 325 DN160	Flair 400 DN180	Sky 150, Exc. 180, Flair 225 DN125	Sky 200/300 DN160
Reducirni kos DN 100-125 za DBOX komoro		koda	UB188637		
		cena	<b>19,82</b>		
Priključni kit za komoro DBOX 206, DN125		koda	UB188636		
		cena	<b>22,70</b>		
Regulacijski element pretoka zraka za DBOX komore (10 kos v kompletu)		koda	UB188564		
		cena/kpl	<b>8,15</b>		
Kulise za dušenje zvoka za DBOX plastično komoro		koda	UB188039		
		cena/kpl	<b>35,08</b>		
Čep za plastično DBOX komoro (10 kos v kompletu)		koda	UB188563		
		cena/kpl	<b>10,27</b>		
Regulacijski element pretoka zraka za DBOX komoro		koda	BR630929		
		cena/kos	<b>4,00</b>		
Naziv		Sky 150 DN125	Sky 200/300 DN160		
Komora dovodno/odvodna za SKY 150, 20 x DN75, vključno z dvema reducirnimi kosi z DN 160 na DN 125 <b>TUDI ZA SKY 200 *</b>		koda	BR423011		
		št. priključkov	2x10		
		cena	<b>630,00</b>		
Komora zvočno/dušilna, odvodno/dovodna za SKY 150/200, 2 x DN125 <b>TUDI ZA SKY 200 *</b>		koda	BR423010		
		št. priključkov	2x1		
		cena	<b>457,00</b>		
Komora zvočno/dušilna dovodno/odvodna za SKY 300, 18 x DN75 <b>SAMO ZA SKY 300 *</b>		koda	BR422501		
		št. priključkov	2x9		
		cena	<b>665,00</b>		
Nastavek za Renovent Sky (če komora za Sky ni priključena direktno na napravo)		koda	BR533004		
		cena	<b>26,00 €</b>		
				<b>BR532004</b>	
			<b>26,00 €</b>		<b>43,00 €</b>



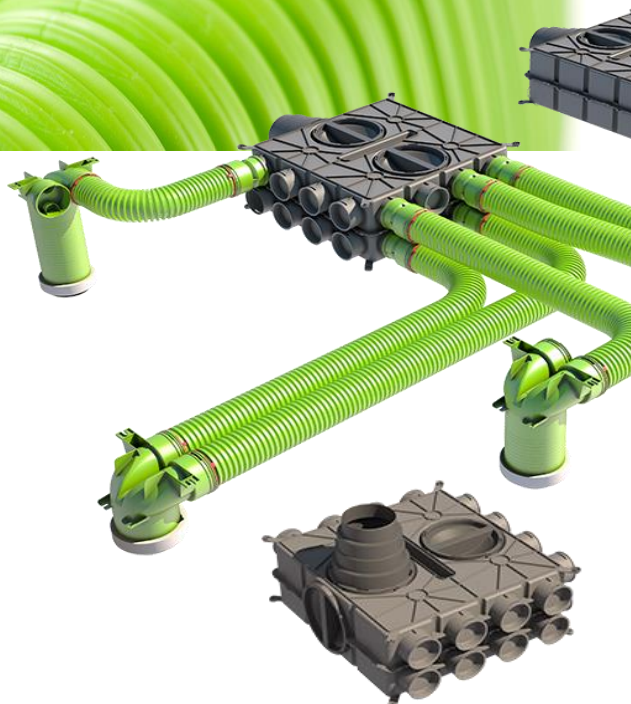

## ► Univerzalne komore serije 800

Univerzalne komore serije 800 so zasnovane po sistemu "ena za vse" in so dobavljive v treh različicah. Komora DB808 ima 8 priključkov, DB816 ima 16 priključkov, DB824 pa 24 priključkov za maksimalno svobodo izbire kombinacij pri montaži.

Priključek za dovod in odvod ima adapter za priključitev cevi dimenzij 125, 150, 160 in 180 mm. Cevi za dovod in odvod se lahko priključi vertikalno ali horizontalno. Serija 800 omogoča tudi vgraditev dodatka za dušenje zvoka, ki absorbira zvok, ki ga proizvaja prezračevalna naprava ter zvok, ki bi se potencialno lahko prenašal med prostori.

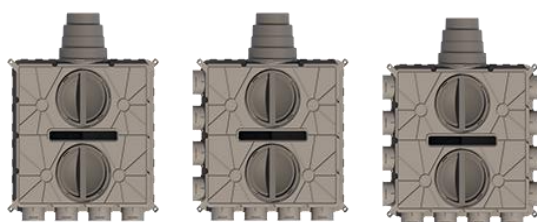

8

16

24

## ► Distribucijske komore serije 200

Komore serije 200 so zasnovane modularno in jih je možno funkcionalno razdeliti, sestaviti, povezati, razstaviti in ponovno montirati glede na trenutne in bodoče potrebe in dimenzijske zahteve objekta. Sistem je sestavljen iz osnovne komore, podaljškov in adapterjev, ki jih lahko sestavimo v en sistem. To omogoča sestavo točno takšnega sistema, kot je potreben za dano situacijo na objektu. Majhna velikost sistema je idealna za vgradnjo v stanovanja ter objekte, ki so prostorsko omejeni. Pri montaži na tla, v steno ali na strop ne potrebujemo dodatnih nosilcev, izvede pa jo lahko ena sama oseba.



6 priključkov



8 priključkov



12 priključkov



















16 priključkov



















12 priključkov

**AIR EXCELLENT - SISTEM ZA RAZVOD PO PROSTORIH - dim. DN 75 (AE34c)**











Naziv - opis	Slika		dim. cevi DN75
Cev za prezračevanje - <b>antistatična &amp; antibakterijska</b> (prodaja kolut po 50 m)		koda cena/m	UB188661 <b>5,39</b>
Pokrov cevi (10 kos v kompletu)		koda cena/kpl	UB188681 <b>17,62</b>
Podaljševalna cevna spojka - konektor		koda cena/kos	UB188350 <b>6,08</b>
Tesnilni obroč DN75/63 mm (10 kos v kompletu)		koda cena/kpl	UB188348 <b>17,03</b>
spojka na klik DN75/63 (10 kos v kompletu)		koda cena/kpl	UB188391 <b>11,67</b>
Koleno za cev DN75 90°		koda cena/kos	UB188173 <b>6,96</b>
Vertikalno koleno - okroglo/ovalno		koda cena/kos	UB188343 <b>15,95</b>
Ravni adapter za prezračevalni ventil 2x75, DN125		koda cena/kos	UB188399 <b>36,41</b>
Kotni adapter za prezračevalni ventil 2x75, DN125		koda cena/kos	UB188342 <b>35,29</b>
Adapter za prezračevalni ventil 1x75, DN125		koda cena/kos	UB188185 <b>31,73</b>
Adapter za talno rešetko 2x75		koda cena/kos	UB188397 <b>33,58</b>
Kanalska objemka (univerzalna - 10 kos v kompletu)		koda cena/kpl	UB188396 <b>17,43</b>
Regulacijska loputa		koda cena/kos	UB188663 <b>16,96</b>
Fleksibilni cevni dušilnik zvoka iz aluminija		koda cena 0,5 m	PRDZ80-125-0,5 <b>58,80</b>
		koda cena 1 m	PRDZ80-125-1 <b>66,00</b>
		koda cena 1,5 m	PRDZ80-125-1,5 <b>73,20</b>
Prehodni kos ravni za prehod iz DN75/63 mm na ovalni 102 x 50 mm (primer pravilne sestave, navedena cena ni za vse sestavne elemente)	 	koda cena/kos	OVA7 <b>12,50</b>
Nož za rezanje zelene cevi DN75		koda cena	UB188691 <b>13,51</b>

**AIR EXCELLENT - SISTEM ZA RAZVOD PO PROSTORIH - dim. 102 x 50 mm (AE23sc)**

Naziv - opis	Slika		dim. cevi 102 x 50 mm
Cev za prezračevanje - antistatična & antibakterijska (prodaja kolut po 50 m)		koda cena/m	UB188299 <b>10,37</b>
Pokrov cevi (10 kos v kompletu)		koda cena/kpl	UB188677 <b>16,57</b>
Zaključni pokrov		koda cena/kos	UB188305 <b>2,75</b>
Podaljševalna cevna spojka - konektor		koda cena/kos	UB188306 <b>10,29</b>
Spojka med priključkom in cevjo		koda cena/kos	UB188302 <b>4,50</b>
Koleno vertikalno 90°		koda cena/kos	UB188303 <b>12,81</b>
Koleno horizontalno 90°		koda cena/kos	UB188304 <b>15,36</b>
Kanalska objemka (univerzalna - 10 kos v kompletu)		koda cena/kpl	UB188396 <b>17,43</b>
Priključek za komoro okroglo/ovalni		koda cena/kos	UB188554 <b>9,96</b>
Vertikalno koleno - okroglo/ovalno		koda cena/kos	UB188343 <b>15,95</b>
Adapter za prezračevalni ventil 1x dim. 102x50 DN125		koda cena/kos	UB188184 <b>35,02</b>
Kotni adapter za prezračevalni ventil 2x dim. 102x50, DN125		koda cena/kos	UB188300 <b>32,11</b>
Adapter za talno rešetko 2x dim. 102 x 50		koda cena/kos	UB188308 <b>35,49</b>
Ravni adapter za prezračevalni ventil 2 x dim. 102 x 50, DN125		koda cena/kos	UB188310 <b>41,58</b>
Prehodni kos ravni za prehod iz DN75/63 mm na ovalni 102 x 50 mm (primer pravilne sestave, navedena cena ni za vse sestavne elemente)	 	koda cena/kos	OVA7 <b>12,50</b>

**SAMO PO NAROČILU!**

**AIR EXCELLENT - SISTEM ZA RAZVOD PO PROSTORIH - dim. DN 90 (AE48c)**

Naziv - opis	Slika		dim. cevi DN90
Cev za prezračevanje - <b>antistatična &amp; antibakterijska</b> (prodaja kolut po 50 m)		koda cena/m	UB188662 <b>7,09</b>
Pokrov cevi (10 kos v kompletu)		koda cena/kpl	UB188676 <b>25,46</b>
Zaključni pokrov		koda cena/kos	UB188381 <b>3,96</b>
Podaljševalna cevna spojka - konektor		koda cena/kos	UB188365 <b>8,95</b>
Tesnilni obroč DN 90/75 mm (10 kos v kompletu)		koda cena/kpl	UB188366 <b>19,47</b>
Spojka na klik DN 90/75 mm (10 kos v kompletu)		koda cena/kpl	UB188392 <b>12,77</b>
Kanalska objemka (univerzalna - 10 kos v kompletu)		koda cena/kpl	UB188396 <b>17,43</b>
Koleno za cev dim. DN 90 - 90°		koda cena/kos	UB188174 <b>17,22</b>
Prehodni kos z dimenzije DN 90 na 130 x 60		koda cena/kos	UB188585 <b>16,04</b>
Kotni adapter za prezračevalni ventil 1x90, DN125		koda cena/kos	UB188188 <b>33,01</b>
Kotni adapter za prezračevalni ventil 2x90, DN125		koda cena/kos	UB188380 <b>36,19</b>
Adapter za DBOX - CEV		koda cena/kos	UB188553 <b>9,90</b>
Fleksibilni cevni dušilnik zvoka iz aluminija		koda cena 0,5 m	PRDZ100-150-0,5 <b>61,20</b>
		koda cena 1 m	PRDZ100-150-1 <b>68,40</b>
		koda cena 1,5 m	PRDZ100-150-1,5 <b>74,40</b>













**SAMO PO NAROČILU!**

**AIR EXCELLENT - SISTEM ZA RAZVOD PO PROSTORIH - dim. 130 x 60 mm (AE35sc)**

Naziv - opis	Slika		dim. cevi 130 x 60
Cev za prezračevanje - antistatična & antibakterijska (prodaja kolut po 30 m)		koda cena/m	UB188373 <b>12,38</b>
Cev za prezračevanje - antistatična & antibakterijska (prodaja kolut po 20 m)		koda cena/m	UB201100003140 <b>12,38</b>
Pokrov cevi (10 kos v kompletu)		koda cena/kpl	UB188678 <b>17,17</b>
Zaključni pokrov		koda cena/kos	UB188155 <b>2,49</b>
Podaljševalna cevna spojka - konektor		koda cena/kos	UB188156 <b>10,69</b>
Spojka med priključkom in cevjo		koda cena/kos	UB188152 <b>5,29</b>
Kanalska objemka (univerzalna - 10 kos v kompletu)		koda cena/kpl	UB188396 <b>17,43</b>
Koleno vertikalno 90°		koda cena/kos	UB188153 <b>13,53</b>
Koleno horizontalno 90°		koda cena/kos	UB188154 <b>13,53</b>
Priključek za komoro okroglo/ovalni		koda cena/kos	UB188555 <b>10,55</b>
Prehodni kos z dimenzije DN 90 na 130 x 60		koda cena/kos	UB188585 <b>16,04</b>
Adapter za prezračevalni ventil 1x dim 130x60, DN125		koda cena/kos	UB188186 <b>35,02</b>
Kotni adapter za prezračevalni ventil, 2x dim. 130x60, DN125		koda cena/kos	UB188150 <b>31,45</b>
Ravni adapter za prezračevalni ventil, 2 x dim. 130 x 60, DN125		koda cena/kos	UB188164 <b>32,15</b>

**SAMO PO NAROČILU!**









**AIR EXCELLENT - SISTEM ZA RAZVOD PO PROSTORIH - dim. 140 x 50 mm (AE45sc)**

Naziv - opis	Slika		dim. cevi 140 x 50
Cev za prezračevanje - antistatična & antibakterijska (prodaja kolut po 20 m)		koda cena/m	UB188668 <b>14,47</b>
Pokrov cevi (10 kos v kompletu)		koda cena/kpl	UB188679 <b>17,72</b>
Zaključni pokrov		koda cena/kos	UB188557 <b>2,94</b>
Podaljševalna cevna spojka - konektor		koda cena/kos	UB188551 <b>15,77</b>
Spojka med priključkom in cevjo		koda cena/kos	UB188550 <b>11,51</b>
Kanalska objemka (univerzalna - 10 kos v kompletu)		koda cena/kpl	UB188396 <b>17,43</b>
Koleno vertikalno 90°		koda cena/kos	UB188558 <b>21,47</b>
Koleno horizontalno 90°		koda cena/kos	UB188559 <b>19,51</b>
Priključek za komoro okroglo/ovalni		koda cena/kos	UB188556 <b>10,56</b>
Kotni adapter za prezračevalni ventil 2x dim. 140 x 50, DN125		koda cena/kos	UB188561 <b>41,91</b>
Adapter za prezračevalni ventil 1x dim.140x50, DN 125		koda cena/kos	UB188187 <b>38,64</b>
Adapter za talno rešetko 1 x dim. 140 x 60		koda cena/kos	UB188560 <b>46,44</b>
Prehodni kos 90° iz ovalne cevi 50x140 mm na okroglo 2x DN75/63mm		koda cena/kos	UB188562 <b>26,50</b>

**SAMO PO NAROČILU!**

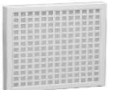

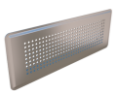

## DISTRIBUCIJSKI ELEMENTI

### VENTILI, REŠETKE

Naziv	Slika		Ident Cena
Ventil prezračevalni DOVODNI DN125		koda cena	UB188050 <b>12,61</b>
Ventil prezračevalni ODVODNI DN125		koda cena	UB188049 <b>12,61</b>
Dovodno-odvodni prezračevalni ventil tip Haelix Rondo, dim. 125, barve RAL9016		koda cena	UB188060 <b>43,13</b>
Dovodno-odvodni prezračevalni ventil tip Haelix Quadro, dim. 125, barev RAL9016		koda cena	UB188061 <b>43,13</b>
Kuhinjska rešetka s filtrom dimenzije maske (ŠxVxG): 220x220x30 mm		koda cena	BR925080 <b>115,50</b>
Kuhinjska rešetka s filtrom - vgradna (knauf) dimenzije maske: (ŠxVxG): 250x250x5 mm potrebna odprtina: 225 x 225 mm		koda cena	BR925080Z <b>174,00</b>
Ventil prezračevalni tip Borea za odvod ali dovod zraka stenska ali stropna montaža DN125		koda cena	SYS00125 <b>28,30</b>
Talna prezračevalna rešetka, inox		koda cena	UB188317 <b>71,40</b>
Talna prezračevalna rešetka, barve RAL9010		koda cena	UB188316 <b>78,89</b>

## VENTMANN DIFUZORJI

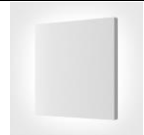

Naziv	Slika	Koda	Cena
<b>Okrogli difuzorji</b>			
Okrogli, priklp 100 mm		VMCIRCLE100	84,00
Okrogli, priklp 125 mm		VMCIRCLE125	52,50
Okrogli, priklp 160 mm		VMCIRCLE160	140,00
Okrogli, priklp 200 mm		VMCIRCLE200	183,00
Okrogli, priklp 250 mm		VMCIRCLE250	183,00
<b>Kvadratni difuzorji</b>			
Kvadratni, priklp 100 mm		VMSQUARE100	98,00
Kvadratni, priklp 125 mm		VMSQUARE125	62,50
<b>Okrogli stenski difuzor</b>			
Okrogli stenski, priklp 100 mm		VMSIDE0100	150,00
Okrogli stenski, priklp 125 mm		VMSIDE0125	150,00
Okrogli stenski, priklp 200 mm		VMSIDE0200	233,00
Okrogli stenski, priklp 250 mm		VMSIDE0250	233,00
<b>Kvadratni stenski difuzor</b>			
Kvadratni stenski, priklp 100 mm		VMSIDE4100	150,00
Kvadratni stenski, priklp 125 mm		VMSIDE4125	135,00
Kvadratni stenski, priklp 160 mm		VMSIDE4160	168,00
Kvadratni stenski, priklp 200 mm		VMSIDE4200	233,00
Kvadratni stenski, priklp 250 mm		VMSIDE4250	233,00
<b>Linjski difuzor "Line"</b>			
Dolžine 625 mm, enojna reža širine 12 mm		VMLINE625112	97,50
Dolžine 1000 mm, enojna reža širine 12 mm		VMLINE1000112	104,00
Dolžine 1250 mm, enojna reža širine 12 mm		VMLINE1250112	130,00
Dolžine 625 mm, enojna reža širine 18 mm		VMLINE625118	97,50
Dolžine 1000 mm, enojna reža širine 18 mm		VMLINE1000118	104,00
Dolžine 1250 mm, enojna reža širine 18 mm		VMLINE1250118	130,00
Dolžine 625 mm, dvojna reža širine 12 mm		VMLINE625212	130,00
Dolžine 1000 mm, dvojna reža širine 12 mm		VMLINE1000212	140,00
Dolžine 1250 mm, dvojna reža širine 12 mm		VMLINE1250212	150,00
Dolžine 625 mm, dvojna reža širine 18 mm		VMLINE625218	130,00
Dolžine 1000 mm, dvojna reža širine 18 mm		VMLINE1000218	140,00
Dolžine 1250 mm, dvojna reža širine 18 mm		VMLINE1250218	150,00
Dolžine 625 mm, trojna reža širine 12 mm		VMLINE625312	160,00
Dolžine 1000 mm, trojna reža širine 12 mm		VMLINE1000312	173,00
Dolžine 1250 mm, trojna reža širine 12 mm		VMLINE1250312	188,00
Dolžine 625 mm, trojna reža širine 18 mm		VMLINE625318	160,00
Dolžine 1000 mm, trojna reža širine 18 mm		VMLINE1000318	173,00
Dolžine 1250 mm, trojna reža širine 18 mm		VMLINE1250318	188,00



## VENTMANN DIFUZORJI

Priključni difuzorji			
L-625 mm, za 1 do 2 reži, za velikost cevi 75 mm		VMGTG75625	<b>115,00</b>
L-1000 mm, za 1 do 2 reži, za velikost cevi 75 mm		VMGTG751000	<b>115,00</b>
L-1250 mm, za 1 do 2 reži, za velikost cevi 75 mm		VMGTG751250	<b>115,00</b>
L-625 mm, za 1 do 2 reži, za velikost cevi 125 mm		VMGTG125625	<b>128,00</b>
L-1000 mm, za 1 do 2 reži, za velikost cevi 125 mm		VMGTG1251000	<b>128,00</b>
L-1250 mm, za 1 do 2 reži, za velikost cevi 125 mm		VMGTG1251250	<b>128,00</b>
L-625 mm, za 1 do 2 reži, za velikost cevi 160 mm		VMGTG160625	<b>130,00</b>
L-625 mm, za 1 do 2 reži, za velikost cevi 160 mm		VMGTG1601000	<b>130,00</b>
L-625 mm, za 1 do 2 reži, za velikost cevi 160 mm		VMGTG1601250	<b>130,00</b>
L-625 mm, za 3 reže, za velikost cevi 125 mm		VMGTG3125625	<b>123,00</b>
L-1000 mm, za 3 reže, za velikost cevi 125 mm		VMGTG31251000	<b>123,00</b>
L-1250 mm, za 3 reže, za velikost cevi 125 mm		VMGTG31251250	<b>123,00</b>
L-625 mm, za 3 reže, za velikost cevi 160 mm		VMGTG3160625	<b>135,00</b>
L-1000 mm, za 3 reže, za velikost cevi 160 mm		VMGTG31601000	<b>135,00</b>
L-1250 mm, za 3 reže, za velikost cevi 160 mm		VMGTG31601250	<b>135,00</b>

Spojka za cevi fi 75 za difuzor Ventmann		VMLINE75SPOJKA	<b>6,80</b>
--	---	----------------	-------------

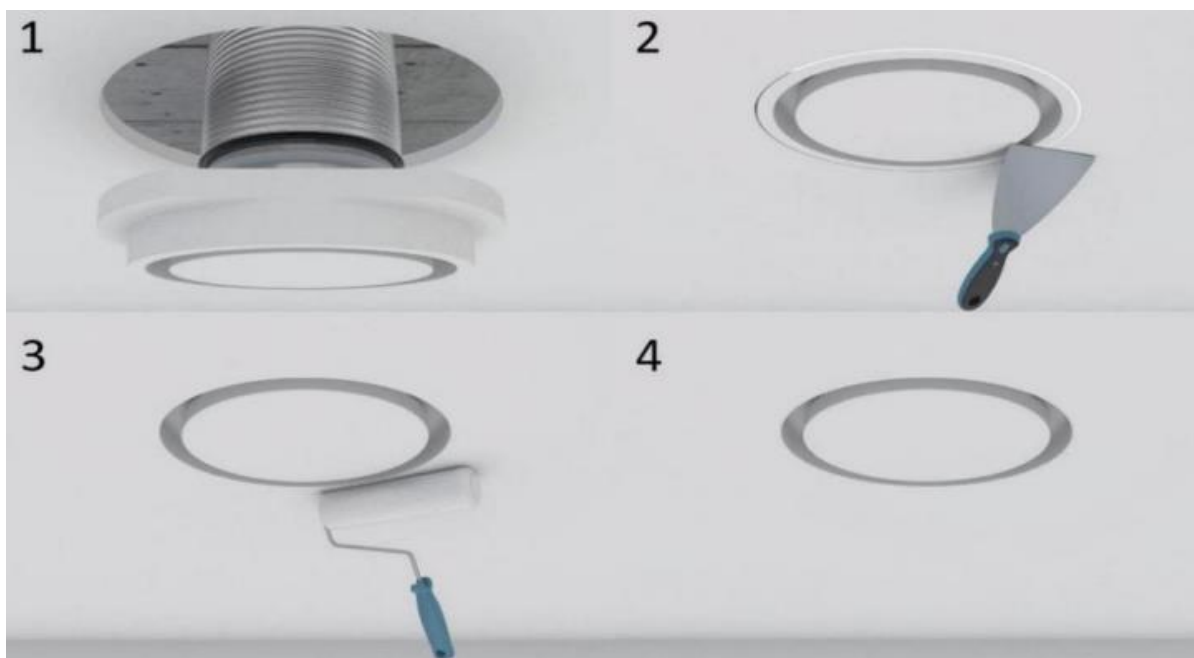

### Prednosti mavčnih difuzorjev Ventmann so očitne











Inovativnost – prvi na trgu iz posebnega mavčnega kompozita.

Moderna oblika – njihov proizvodni proces je prilagodljiv in okolju prijazen, možnosti vgradnje pa skoraj neomejene.

Eleganca – pomagajo ohraniti celovitost notranje opreme in se popolnoma zlijejo s stenskimi in stropnimi površinami.

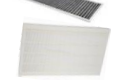
Lažje pleskanje – ker so difuzorji nameščeni skupaj s stropom ali stenami, jih je mogoče prebarvati z isto barvo.

Noben izmed mavčnih difuzorjev Ventmann ne ustvari okvirja na površini, na katero je nameščen. Ta učinek dosežemo tako, da jih pri vgradnji izravnamo s stropom ali steno.

FILTRI ZA PREZRAČEVALNE NAPRAVE									
Naziv	Slika		Exc. 300	Exc. 400/450	Sky 150/200 Exc. 180	Sky 300	Flair 325/400	Flair 225	
			DN160	DN180	DN125	DN160	DN160	DN125	
filter kvalitete G4 Coarse 60%		koda	PRFEX300/400/450					PRFFLAIR325	PRFFLAIR225
		cena/kos	12,75					15,14	15,14
filter kvalitete F7, EMP2,5 70%		koda	PRFEX7300/400/450		BR533001	BR532001	BR532702	BR532791	
		cena/kos	25,44		21,00	21,00	59,00	50,00	
komplet dovodni/odvodni filter F7(EMP2,5 70%)/G4 (Coarse 60%)		koda			BR533002	BR532002			
		cena/kpl			27,00	30,00			
kasetna filter za Renovent Excellent 300/400/450		koda	PRKFREX300/400						
		cena/kos	50,35						
filter G4 za kaseto (10 kos v kompletu) Coarse 60%		koda	PRFTREX300/400		PRFTSKY150/200 (samo Sky)	PRFTSKY300	PRFLAIR325/40 OG4		
		cena/kpl	25,71		28,20	34,80	17,00		
filter G2 za Brink kuhinjsko rešetko - 5 kos v kompletu		koda	PRFIKUH2						
		cena/kpl	20,00						
Aktivni karbonski filter		koda	BR532227		BR532228	BR532229	BR532704	BR532793	
		cena/kpl	73,00		34,00	41,00	90,00	61,00	
Komplet dovodni / odvodni filter, aktivni karbonski filter / G4 filter		koda					BR532705	BR532794	
		cena/kpl					104,00	75,00	
Stožičasti filter G4 DN125 16cm višina (10 kos v kompletu)		koda	PRFStožec125						
		cena/kpl	26,00						
Komplet filtrov 1x F7 za dovod in 2x G4 za izpuh. *za AIR70*		koda	BR450109						
		cena/kpl	64,00 €						
Komplet filtrov G4 *za AIR70* 3 kos		koda	BR536006						
		cena/kpl	28,00 €						

## Komerciala

Uroš Bogatin  
+386 41 328 231  
[uros.bogatin@atermika.si](mailto:uros.bogatin@atermika.si)

Branko Damiš  
+386 31 509 936  
[branko.damis@atermika.si](mailto:branko.damis@atermika.si)

Denis Horvat  
+386 31 697 005  
[denis.horvat@atermika.si](mailto:denis.horvat@atermika.si)

Robert Horvat  
+386 41 557 830  
[robert.horvat@atermika.si](mailto:robert.horvat@atermika.si)

Domen Žunkovič  
+386 41 350 981  
[domen.zunkovic@atermika.si](mailto:domen.zunkovic@atermika.si)